

INSTALLATION INSTRUCTIONS

Model: **OW2450**
Fixture Family: **PLURAL OUTDOOR SCNCE**
Document Description: Installation Instructions for
PLURAL Series Luminaires

VISA LIGHTING
AN OLDENBURG GROUP COMPANY
1717 West Civic Drive Milwaukee, WI 53209
414-354-6600
Design Modification Rights Reserved
© Visa Lighting

Drawing: 762026XX

Rev: A

Sheet: 1 of 7

Eng: SLN

Date Drawn: 07/15/15

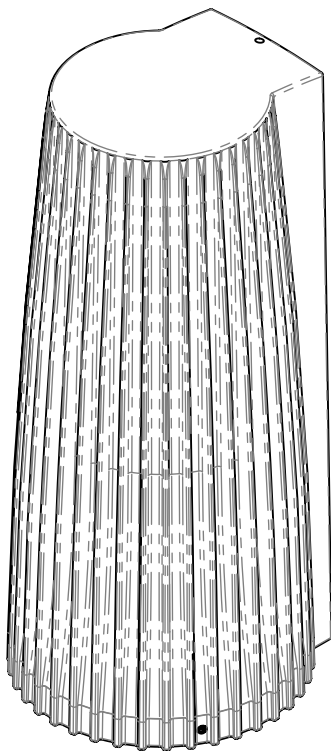

TABLE OF CONTENTS:

SHEET 2: MULLION SYSTEM INSTALLATION

**SHEET 3: REMOTE DRIVER BOX
INSTALLATION**

**SHEET 4: 2 X 4 EXTERIOR JUNCTION BOX
TRANSITION PLATE INSTALLATION**

**SHEET 5: 2 X 4 EXTERIOR JUNCTION BOX
INSTALLATION**

**SHEET 6: 4 X 4 EXTERIOR JUNCTION BOX
TRANSITION PLATE INSTALLATION
(WITH JUNCTION BOX COVER OPTION)**

**SHEET 7: OCTAGON JUNCTION BOX
INSTALLATION**

! When using electrical equipment, basic safety precautions should always be followed, including the following:

- Read all instructions carefully before installing and save for future use.
- Make sure all connections are in accordance with the National Electrical Code and local regulations.
- To avoid possible electric shock, be sure the power supply is turned off before servicing or installing the fixture.
- Service should be performed by qualified personnel.
- These instructions may not cover all details or variations. If additional information is needed, please contact Visa Lighting.

INSTALLATION INSTRUCTIONS

Model: **OW2450**
Fixture Family: **PLURAL OUTDOOR SCNCE**
Document Description: Installation Instructions for
PLURAL Series Luminaires

1717 West Civic Drive Milwaukee, WI 53209
414-354-6600
Design Modification Rights Reserved
© Visa Lighting

MULLION SYSTEM INSTALLATION

NOTE: THIS INSTALLATION METHOD REQUIRES THE USE OF THE REMOTE DRIVER BOX. PLEASE SEE INCLUDED INSTRUCTIONS FOR INSTALLATION OF REMOTE DRIVER BOX AND ELECTRICAL CONNECTIONS TO FIXTURE THROUGH MULLION SYSTEM

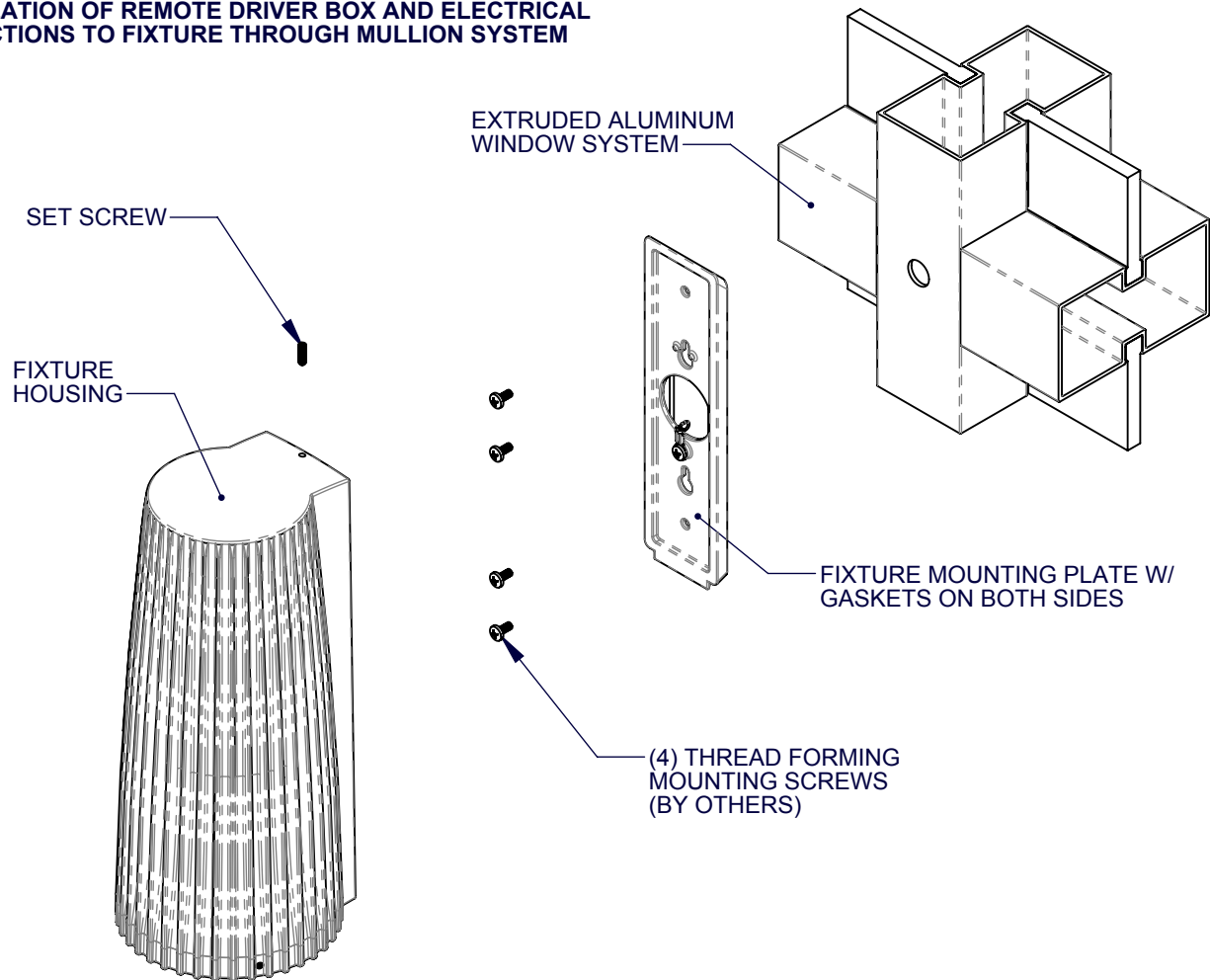

1. Loosen provided #8 set screw at top of fixture housing.
2. Remove fixture mounting plate.
3. Secure fixture mounting plate to aluminum mullion system with thread forming screws (by others)
4. Make electrical connections per code. (See Remote Driver Box Installation Sheet 3)
5. Being careful not to pinch wires, resecure fixture housing to mounting plate by tightening the provided #8 set screw at the top of the fixture housing. Note: for the proper seal, fixture mounting plate must NOT be visible for the side views. Tighten set screws until mounting plate is NOT visible.

For proper wet seal, provide a continuous bead of caulk or silicone at back side of fixture mounting plate when mounting surface is not smooth.

When using electrical equipment, basic safety precautions should always be followed, including the following:

- Read all instructions carefully before installing and save for future use.
- Make sure all connections are in accordance with the National Electrical Code and local regulations.
- To avoid possible electric shock, be sure the power supply is turned off before servicing or installing the fixture
- Service should be performed by qualified personnel.
- These instructions may not cover all details or variations. If additional information is needed, please contact Visa Lighting.

INSTALLATION INSTRUCTIONS



Model: **OW2450**
Fixture Family: **PLURAL OUTDOOR SCNCE**
Document Description: Installation Instructions for
PLURAL Series Luminaires

1717 West Civic Drive Milwaukee, WI 53209
414-354-6600
Design Modification Rights Reserved
© Visa Lighting

INSTRUCTIONS

1. Remove Cover by removing the (4) Cover Screws
2. Mount Remote Box in an accessible area per local and national codes, use fasteners appropriate for the mounting surface (not included)
3. Make line voltage connections in Line voltage Compartment
4. Make remaining class II output connections in the main compartment

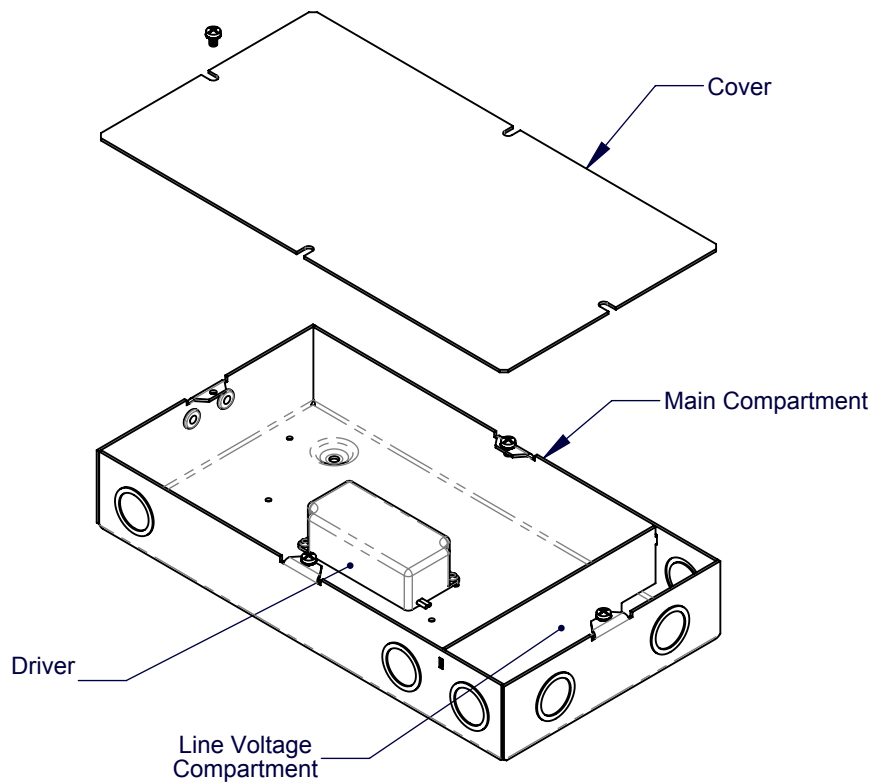

Drawing: 762026XX

Rev: A

Sheet: 3 of 7

Eng: SLN

Date Drawn: 07/15/15

When using electrical equipment, basic safety precautions should always be followed, including the following:

- Read all instructions carefully before installing and save for future use.
- Make sure all connections are in accordance with the National Electrical Code and local regulations.
- To avoid possible electric shock, be sure the power supply is turned off before servicing or installing the fixture.
- Service should be performed by qualified personnel.
- These instructions may not cover all details or variations. If additional information is needed, please contact Visa Lighting.

INSTALLATION INSTRUCTIONS

Model: **OW2450**
Fixture Family: **PLURAL OUTDOOR SCENCE**
Document Description: Installation Instructions for
PLURAL Series Luminaires

VISA LIGHTING
AN OLDENBURG GROUP COMPANY
1717 West Civic Drive Milwaukee, WI 53209
414-354-6600
Design Modification Rights Reserved
© Visa Lighting

2 X 4 JUNCTION BOX INSTALLATION (Exterior 2x4 Junction box shown in illustration)

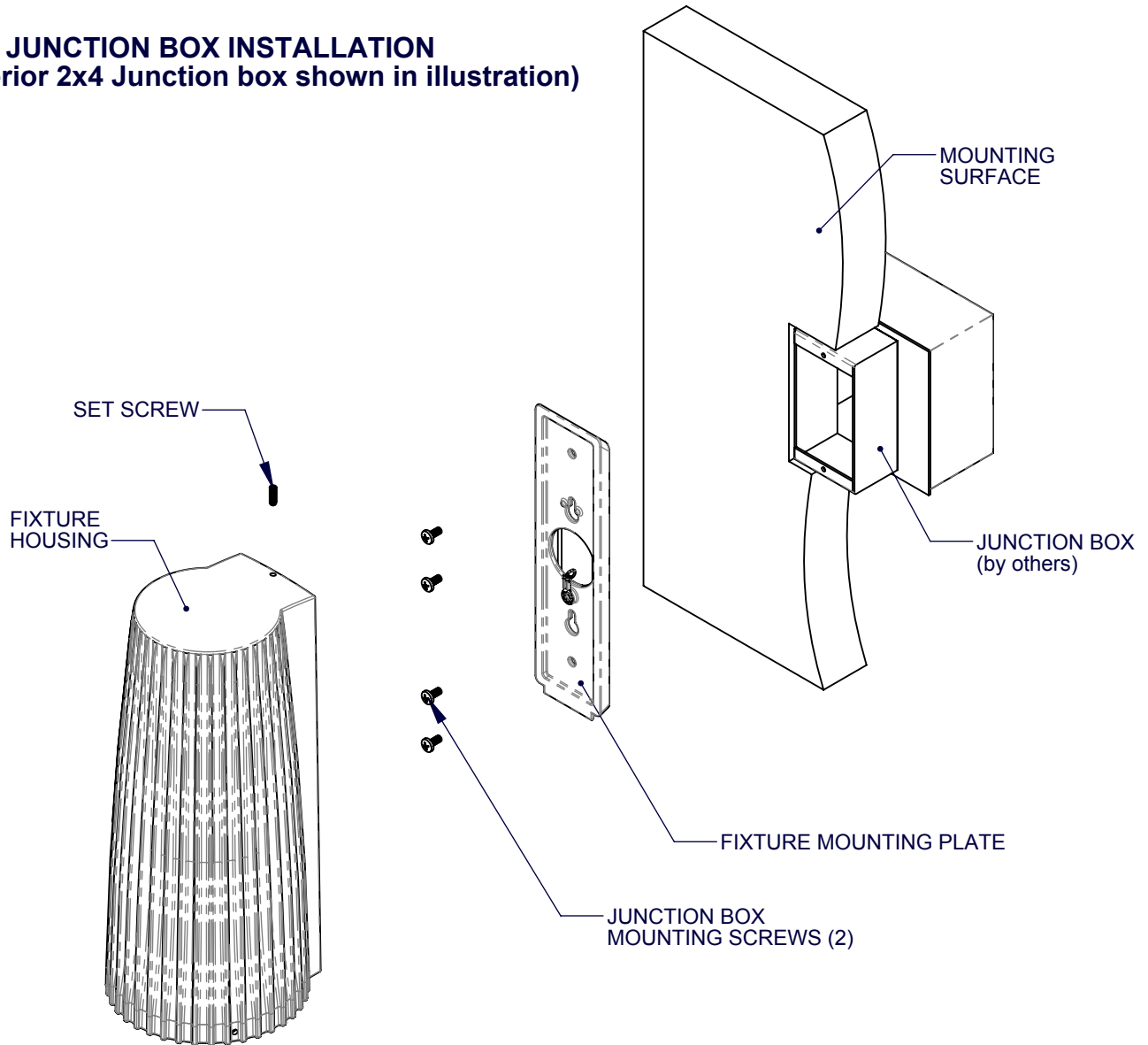

1. Loosen provided #8 set screw at top of fixture housing.
2. Remove fixture mounting plate.
3. Secure fixture mounting plate to junction box at wall with screws (by others).
4. Make electrical connections per code.
5. Being careful not to pinch wires, resecure fixture housing to mounting plate by tightening the provided #8 set screw at the top of the fixture housing. Note: for proper seal, fixture plate must NOT be visible from the side views. Tighten set screw until mounting plate is not visible.

For proper wet seal, provide a continuous bead of caulk or silicone at back side of fixture mounting plate when mounting surface is not smooth.

When using electrical equipment, basic safety precautions should always be followed, including the following:

- Read all instructions carefully before installing and save for future use.
- Make sure all connections are in accordance with the National Electrical Code and local regulations.
- To avoid possible electric shock, be sure the power supply is turned off before servicing or installing the fixture.
- Service should be performed by qualified personnel.
- These instructions may not cover all details or variations. If additional information is needed, please contact Visa Lighting.

Drawing: 762026XX

Rev: A

Sheet: 4 of 7

Eng: SLN

Date Drawn: 07/15/15

INSTALLATION INSTRUCTIONS

Model: **OW2450**
Fixture Family: **PLURAL OUTDOOR SCENCE**
Document Description: Installation Instructions for
PLURAL Series Luminaires

VISA LIGHTING
AN OLDENBURG GROUP COMPANY
1717 West Civic Drive Milwaukee, WI 53209
414-354-6600
Design Modification Rights Reserved
© Visa Lighting

2 X 4 JUNCTION BOX INSTALLATION

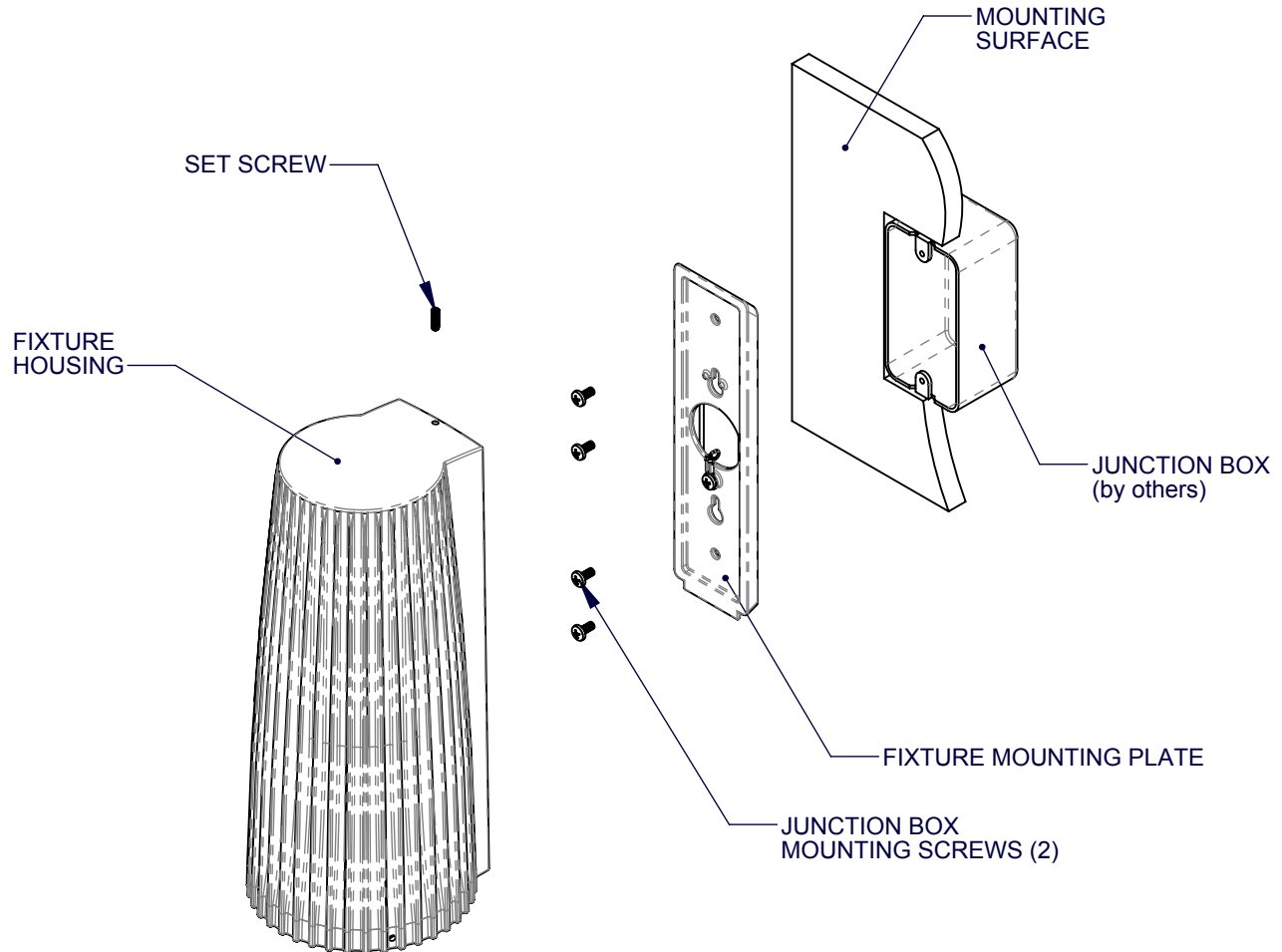

1. Loosen provided #8 set screws at top of fixture housing.
2. Remove fixture mounting plate.
3. Secure fixture mounting plate to junction box at wall with screws (by others)
4. Make electrical connections per code.
5. Being careful not to pinch wires, resecure fixture mounting plate by tightening the provided #8 set screw at the top of the fixture housing . Note: for proper seal, fixture mounting plate must NOT be visible from the side views. Tighten set screw until mounting plate is not visible.

For proper wet seal, provide a continuous bead of caulk or silicone at back side of the fixture mounting plate when mounting surface is not smooth.

When using electrical equipment, basic safety precautions should always be followed, including the following:

- Read all instructions carefully before installing and save for future use.
- Make sure all connections are in accordance with the National Electrical Code and local regulations.
- To avoid possible electric shock, be sure the power supply is turned off before servicing or installing the fixture
- Service should be performed by qualified personnel.
- These instructions may not cover all details or variations. If additional information is needed, please contact Visa Lighting.

Drawing: 762026XX

Rev: A

Sheet: 5 of 7

Eng: SLN

Date Drawn: 07/15/15

INSTALLATION INSTRUCTIONS



Model: **OW2450**
Fixture Family: **PLURAL OUTDOOR SCNCE**
Document Description: Installation Instructions for
PLURAL Series Luminaires

1717 West Civic Drive Milwaukee, WI 53209
414-354-6600
Design Modification Rights Reserved
© Visa Lighting

ALTERNATIVE SIZE JUNCTION BOX INSTALLATION WITH JUNCTION BOX COVER OPTION (Exterior 4x4 Junction box with Transition Plate shown in illustration)

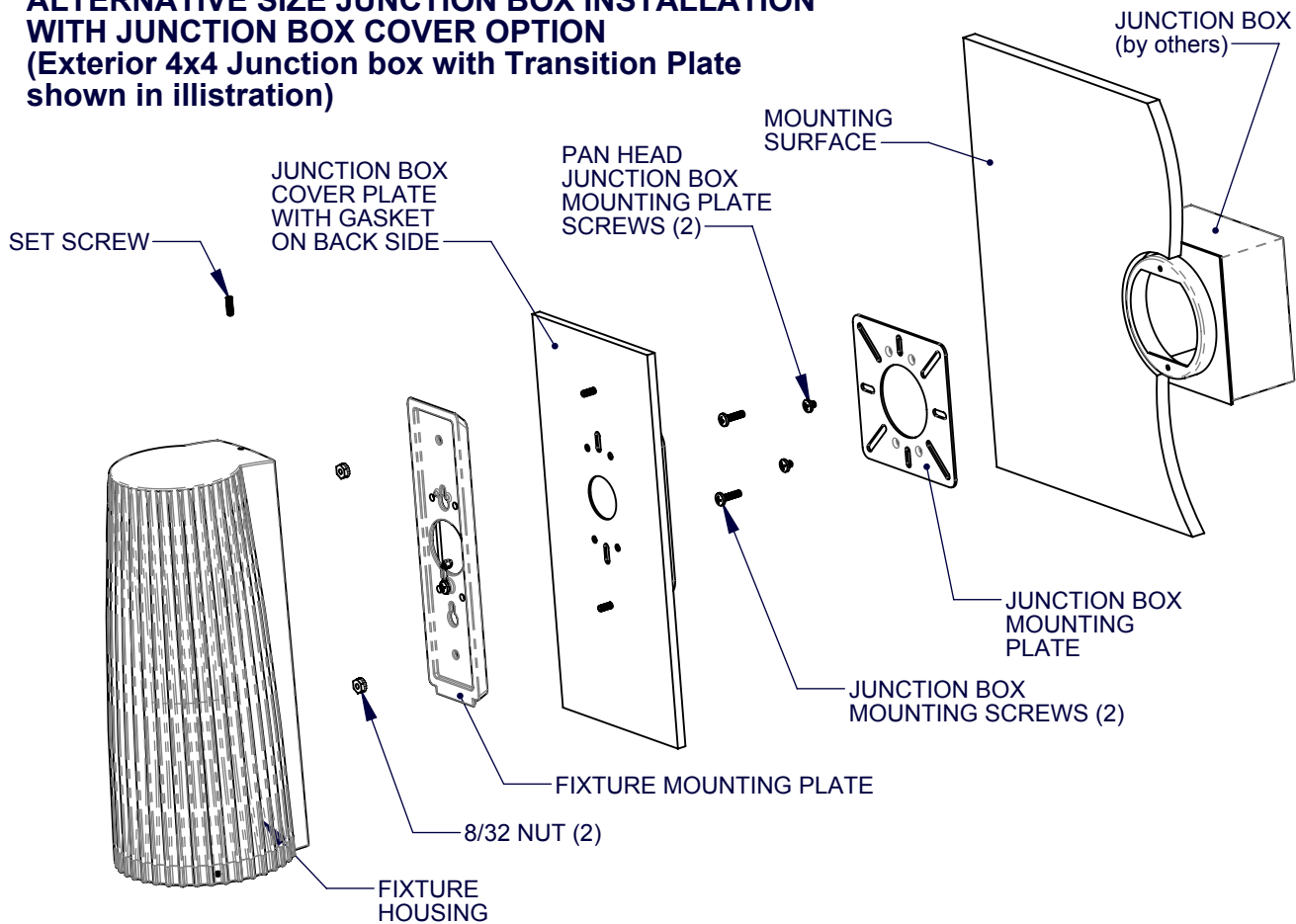

1. Loosen provided #8 set screw at top of fixture housing.
2. Remove fixture mounting plate, junction box cover plate and junction box mounting plate assembly.
3. Loosen and remove provided #8 pan head fixture mounting plate screws (set to side for reassembly later).
4. Secure junction box cover mounting plate to junction box with screws (by others). **NOTE: verify bracket is level for fixture straightness once fixture is installed.**
5. Using the provided #8 pan head fixture mounting plate screws (set to the side earlier), secure the fixture mounting plate and the junction box cover plate to the junction cover mounting plate now attached to the junction box. Junction box cover plate's 1/4" thick gasket will face the wall.
6. Make electrical connections per code.
7. Being careful not to pinch wires, resecure fixture housing to mounting plate by tightening the provided #8 set screw at the top of the fixture housing. Note: for proper seal, fixture mounting plate must NOT be visible from the side views. Tighten set screw until mounting plate is NOT visible.

For proper wet seal, provide a continuous bead of caulk or silicone at back side of junction box cover plate when mounting surface is not smooth.



When using electrical equipment, basic safety precautions should always be followed, including the following:

- Read all instructions carefully before installing and save for future use.
- Make sure all connections are in accordance with the National Electrical Code and local regulations.
- To avoid possible electric shock, be sure the power supply is turned off before servicing or installing the fixture.
- Service should be performed by qualified personnel.
- These instructions may not cover all details or variations. If additional information is needed, please contact Visa Lighting.

Drawing: 762026XX

Rev: A

Sheet: 6 of 7

Eng: SLN

Date Drawn: 07/15/15

INSTALLATION INSTRUCTIONS



Model: **OW2450**
Fixture Family: **PLURAL OUTDOOR SCNCE**
Document Description: Installation Instructions for
PLURAL Series Luminaires

1717 West Civic Drive Milwaukee, WI 53209
414-354-6600
Design Modification Rights Reserved
© Visa Lighting

OCTAGON JUNCTION BOX INSTALLATION WITH JUNCTION BOX COVER OPTION (Octagon J-Box shown in illustration)

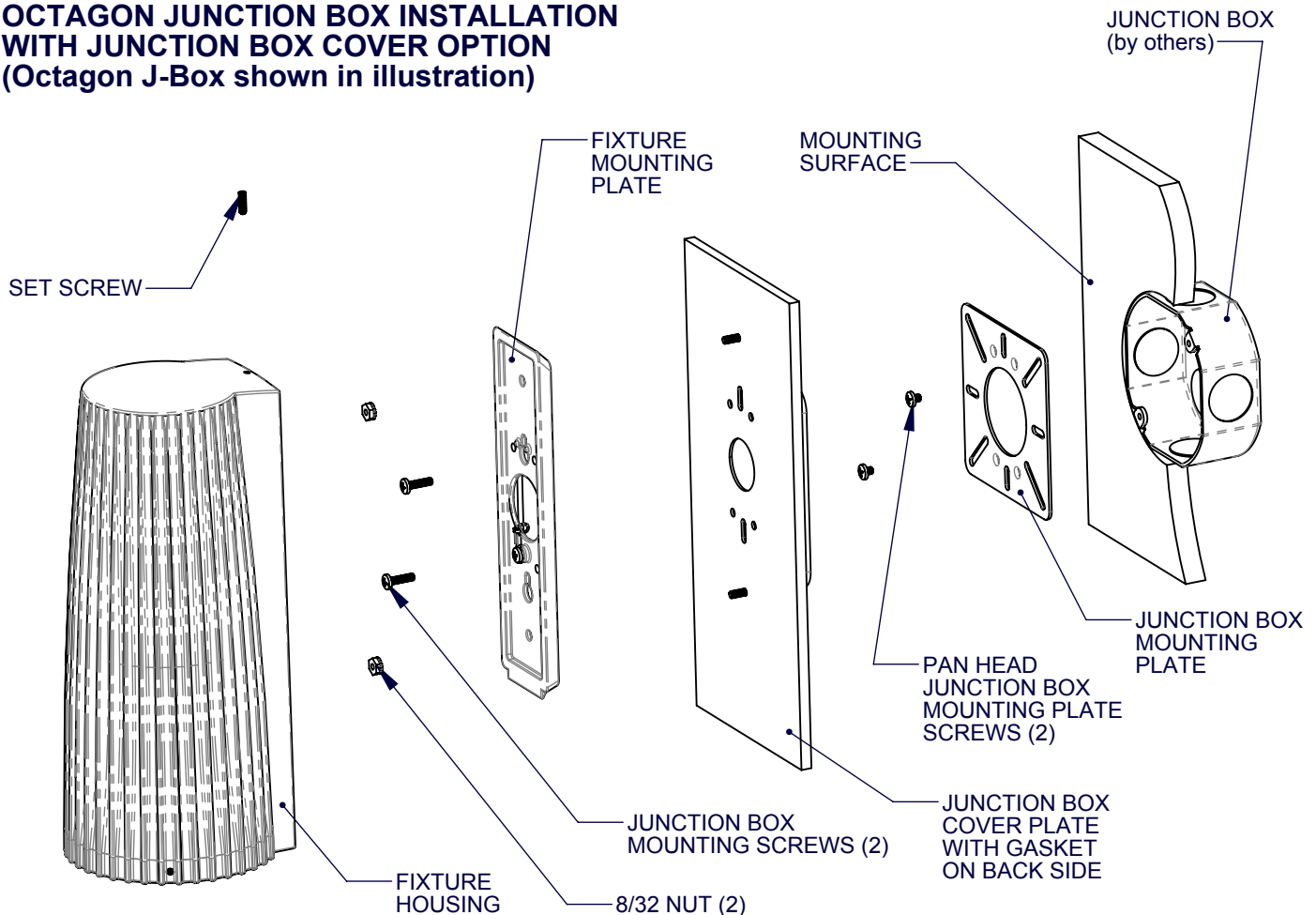

1. Loosen provided #8 set screw at top of fixture housing.
2. Remove fixture mounting plate, junction box cover plate and junction box mounting plate.
3. Loosen and remove provided #8 pan head fixture mounting plate screws (set to the side for reassembly later).
4. Secure junction box cover mounting plate to junction box with screws (by others). **NOTE: Verify bracket is level for fixture straightness once fixture is installed.**
5. Using the provided #8 pan head fixtures mounting plate screws (set to the side earlier), secure the fixture mounting plate and the junction box plate to the junction box cover plate's 1/4" thick gasket will face the wall.
6. Make electrical connections per code.
7. Being careful not to pinch wires, resecure fixture housing to mounting plate by tightening the provided #8 set screw at the top of the fixture housing. Note: for proper seal, fixture mounting plate must NOT be visible from the side views. Tighten set screws until mounting plate is NOT visible.

For proper wet seal, provide a continuous bead of caulk or silicone at back side of junction box cover plate when mounting surface is not smooth.

Drawing: 762026XX

Rev: A

Sheet: 7 of 7

Eng: SLN

Date Drawn: 07/15/15



When using electrical equipment, basic safety precautions should always be followed, including the following:

- Read all instructions carefully before installing and save for future use.
- Make sure all connections are in accordance with the National Electrical Code and local regulations.
- To avoid possible electric shock, be sure the power supply is turned off before servicing or installing the fixture.
- Service should be performed by qualified personnel.
- These instructions may not cover all details or variations. If additional information is needed, please contact Visa Lighting.