

PARALLEL™

CP5562/CP5563/CP5564/CP5565/CP5566/CP5568

4" Wide Pendant – Cable Suspended



VisaLighting.com/products/Parallel

Type: _____ Project: _____ Location: _____

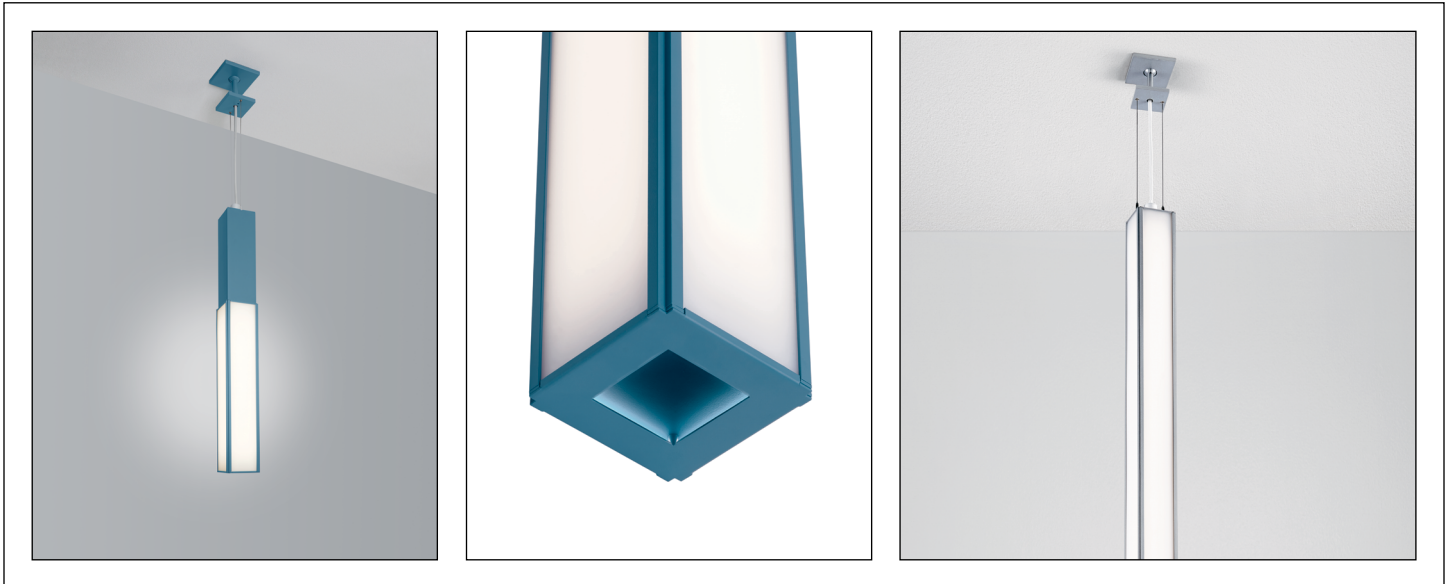

DIMENSIONS^{1,7}

OAH is the distance (in inches) from the bottom of the fixture to the ceiling plane. Example - OAH(192) indicates an overall fixture height of 192"

W = Width OAH = Standard Overall Height X = Body Height WT = Weight

	CP5562	CP5563	CP5564	CP5565	CP5566	CP5568
W	4-1/2" (114 mm)					
OAH	192" (4877 mm)					
X with White LED source						
Top Mount Driver	34" (864 mm)	44-7/8" (1140 mm)	55-5/8" (1413 mm)	70-1/2" (1791 mm)	81-1/4" (2064 mm)	103" (2616 mm)
Remote Driver (RMD)	26" (660 mm)	36-3/4" (933 mm)	47-1/2" (1207 mm)	58-1/4" (1480 mm)	69-1/8" (1756 mm)	90-3/4" (2305 mm)
X with RGB source						
Top Mount Driver	37-7/8" (860 mm)	45-7/8" (1165 mm)	57-5/8" (1464 mm)	76" (1930 mm)	85-1/2" (2172 mm)	109-1/2" (2781 mm)
Remote Driver (RMD)	21-5/8" (549 mm)	33-5/8" (854 mm)	45-1/2" (1156 mm)	63-3/4" (1619 mm)	69-5/8" (1768 mm)	93-5/8" (2378 mm)
WT	12 lbs	13 lbs	15 lbs	18 lbs	19 lbs	22 lbs

RELATIVE SCALE DRAWING

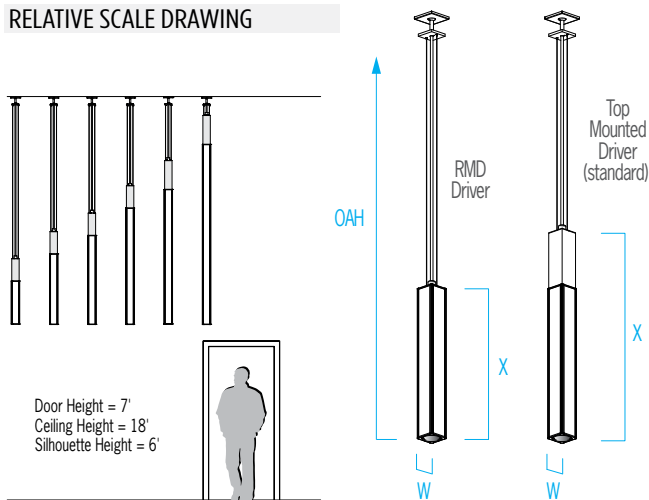

FEATURES

- Top mounted driver is standard; Optional remote driver mountable up to 20' maximum distance
- Color changing RGB is DMX-512 compatible (controls by others) See DMX detail on page 3
- Optional downlight, 0-10V dimmable (controls by others), with Narrow, Medium or Wide optical distribution options
- Power cord is white; cables are stainless steel
- Canopy/Cable/Cord can be shipped ahead to speed installation
- Matte white acrylic panels; optional Lumicor® acrylic panels
- No VOC powder coat finish
- ETL listed for damp locations (not suited for exterior applications)



PARALLEL (cont.)

CP5562/CP5563/CP5564/CP5565/CP5566/CP5568

4" Wide Pendant – Cable Suspended



Fill in shaded boxes using information listed below

- MVOLT								
MODEL¹ CP5562 CP5563 CP5564 CP5565 CP5566 CP5568 See page 1	BODYLIGHT² • L30K L35K • L40K • RGB	DOWNLIGHT³ (Optional) • L30K L35K • L40K Bottom has square aperture with glow when no downlight specified	VOLTAGE MVOLT	DOWNLIGHT⁴ OPTICS MED NRW WIDE Required with Downlight Option	FINISH See last page for finish order codes	DIFFUSER⁵ • KA • OLIN • SL	OPTION(S)⁶ RMD XPS XPS not available on CP5565, CP5566, CP5568	OAH⁷ See page 1

BODYLIGHT SOURCE² (Select One)

Dimmable 0-10V to 1%, Minimum 80CRI, within 3-step MacAdam

Source	CCT	CP5562		CP5563		CP5564		CP5565		CP5566		CP5568	
		Delivered Lumens	Power/Watts	Delivered Lumens	Power/Watts	Delivered Lumens	Power/Watts	Delivered Lumens	Power/Watts	Delivered Lumens	Power/Watts	Delivered Lumens	Power/Watts
• L30K	3000K	1200	11	2100	20	2700	26	3700	36	4400	42	5800	55
L35K	3500K												
• L40K	4000K												
• RGB			12		20		28		40		44		60

Bodylight and downlight are separately switched and controlled/dimmed

DOWNLIGHT SOURCE³

Bottom has square aperture with glow when no downlight specified

Source	CCT	Delivered Lumens	Power/Watts
• L30K	3000K	1800	18
L35K	3500K	1800	
• L40K	4000K	1900	

DOWNLIGHT OPTICS⁴

For downlight only

MED	48° Beam
NRW	34° Beam
WIDE	84° Beam

BOTTOM WITH DOWNLIGHT



BOTTOM – NO DOWNLIGHT



VOLTAGE

MVOLT	120-277V, 50/60 Hz
-------	--------------------

BODYLIGHT LUMEN MAINTENANCE RATING

L80 (reported)	>60,000 hrs
----------------	-------------

DOWNLIGHT LUMEN MAINTENANCE RATING

L80 (reported)	>55,000 hrs
----------------	-------------

DIFFUSER OPTIONS⁵

Diffuser is matte white acrylic if no option is selected

• KA	Kauri Lumicor
• OLIN	Oyster Linen Lumicor
• SL	Silver Spun Lumicor



PHOTOMETRICS

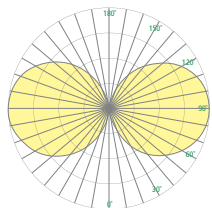

Body Light

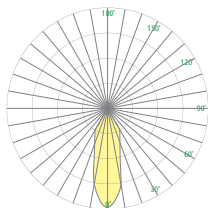

NRW 34° Beam

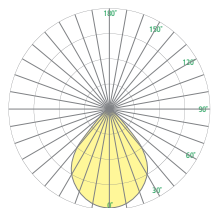

WIDE 84° Beam

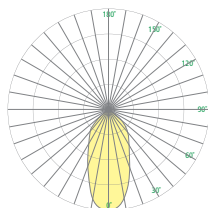

MED 48° Beam

Options continued on Page 3

PARALLEL (cont.)

CP5562/CP5563/CP5564/CP5565/CP5566/CP5568

4" Wide Pendant – Cable Suspended

OPTIONS⁶ (Multiple selections allowed)

▲ Option availability may be interdependent with Other Options

RMD	Remote driver box has knock-outs for conduit connection, may be recess mounted with insulation contact (type IC) Driver is Top Mounted unless RMD option is selected
XPS	Express 10 day shipping. Items marked with a bullet (•) are not available with XPS XPS not available on CP5565, CP5566, CP5568

CANOPY & CABLE SUPPORT



REMOTE DISTANCE INFORMATION

Model	Maximum Recommended Remote Wiring Distance from RMD to fixture canopy			
	12awg	14awg	16awg	18awg
CP5562	1400	900	550	350
CP5563	750	450	300	175
CP5564	550	350	225	125
CP5565	400	250	150	100
CP5566	350	200	125	75
CP5568	275	175	100	50

Distance measured in feet

DMX DETAIL

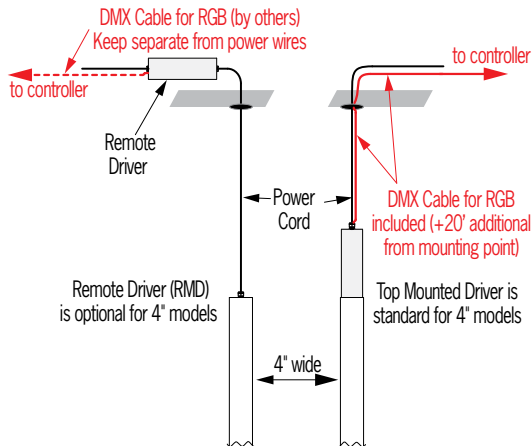

PARALLEL PRODUCT FAMILY

Indoor Sconce		• CB5530
Indoor Pendants	4" Wide	• CP5562, CP5563, CP5564, CP5565, CP5566, CP5568
	8" Wide	• CP5572, CP5573, CP5574, CP5575, CP5576, CP5578
	12" Wide	• CP5582, CP5583, CP5584, CP5585, CP5586, CP5588

SUGGESTED VARIATIONS

- Custom colors
- Stem mount
- Custom graphics

See [Visalighting.com/Products/Parallel](https://www.visalighting.com/Products/Parallel) for more information

PARALLEL (cont.)

CP5562/CP5563/CP5564/CP5565/CP5566/CP5568

4" Wide Pendant – Cable Suspended



FINISHES

Specify color code when ordering. For accurate color matching, individual paint and finish samples are [available upon request](#).
For more information about our finishes visit visalighting.com/finishes

Powder Coat Paint Finishes (Standard)

						
AGGY Agate Grey	ALGN Alpine Green	BJBG Baja Beige	BMAT Bronze Matte	BRNZ Bronze	BSIL Blade Silver	CVBL Cove Blue
						
DEOR Deoro Gold	GLWT Glacier White	GSIL Graphite Silver	HRGR Harbor Grey	JTBK Jet Black	OCBL Ocean Blue	SHGR Shoreline Grey
						
SBGN Sagebrush Green	SLGR Slate Grey	SSTP Sierra Taupe	TRCN Terracotta Canyon	TRWT Traffic White	VBLK Velvet Black	VNRD Vineyard Red