

CP6122 CELEST HX™

Large 48" H - Acoustic Panels



VisaLighting.com/products/Celest-hx

Type: _____ Project: _____ Location: _____

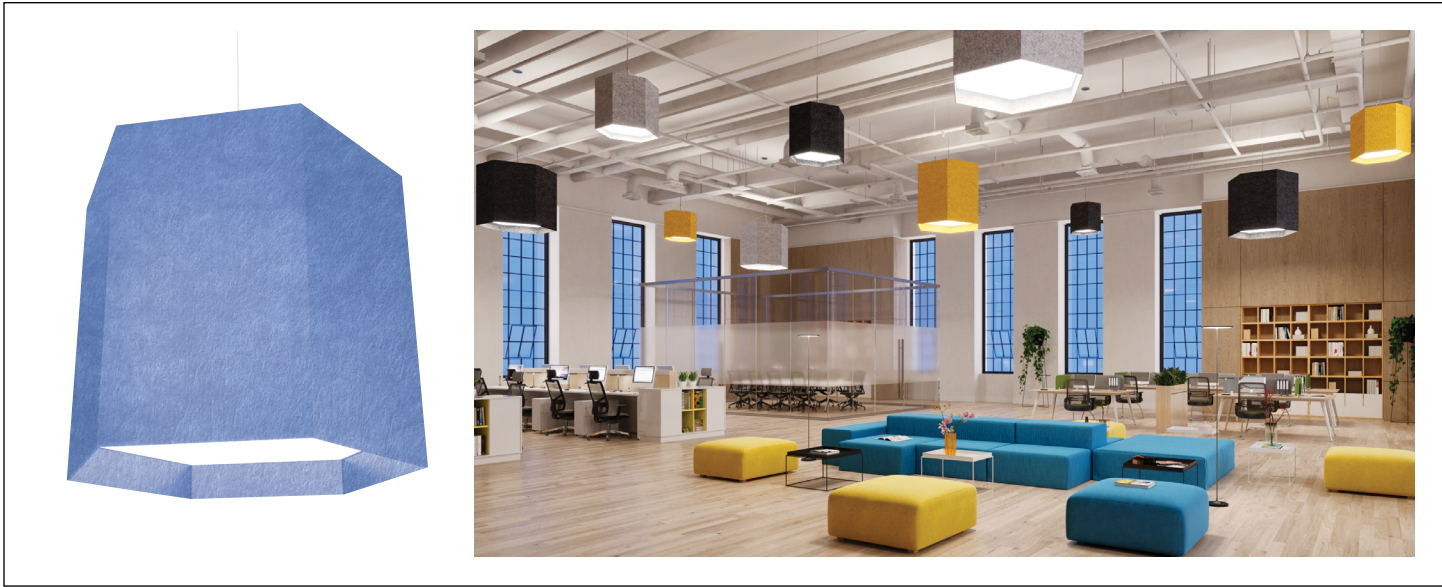

DIMENSIONS⁵

OAH MUST BE SPECIFIED

OAH is the distance (in inches) from the bottom of the fixture to the ceiling plane.

X = Body Height OAH = Overall Height WT = Weight

X	48" (1219 mm)
OAH	96" (2438 mm)
WT	<150 lb

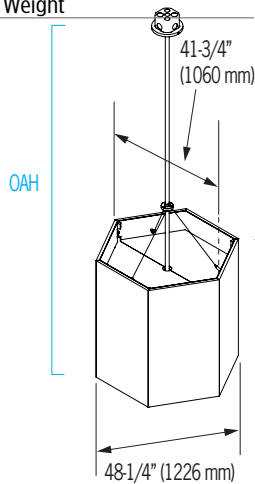
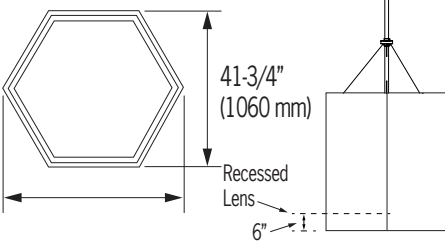

RELATIVE SCALE DRAWING

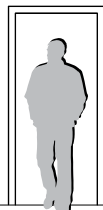
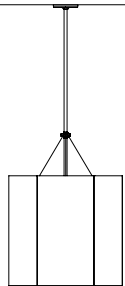

Door Height = 7'
Ceiling Height = 18'
Silhouette Height = 6'

FEATURES

- Integral drivers
- Up & down light available in Direct-Indirect (DIRIND) or Semi-Indirect (SEMIND) distribution
- Uplight and downlight separately switched and dimmed (may be wired together during installation)
- Swivel ball & stem mount directly to structural blocking; wire connections can be made through a 4" octagonal 2-1/8" deep electrical junction box (by others)
- Inner luminous assembly suspended directly by stem, may be suspended and wired separately with outer shade panels installed later
- Outer shade panel assembly suspended via aircraft cables to stem collar with fittings concealed behind panels for height and levelling adjustment
- Frosted acrylic top and bottom lenses
- Shade panels are shipped disassembled for flat packing
- 100% recyclable polyester (PET) sound absorbing acoustic panels
- Acoustic panels meet fire resistant standard Class A (ASTM E-84)
- Non-VOC powder coat finish on stem and canopy and interior reflector
- ETL listed for damp locations. Not suited for exterior applications

PHOTOMETRICS

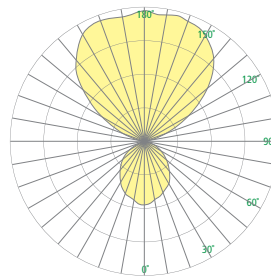

Semi-Indirect (SEMIND)

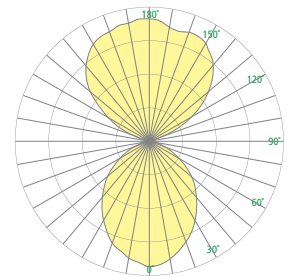

Direct-Indirect (DIRIND)



ETL Listed



5 Year Warranty

CP6122 CELEST HX (cont.)

Large 48" H - Acoustic Panels



Fill in shaded boxes using information listed below

CP6122	MODEL	SOURCE ¹ L30K(H) L30K(L) L35K(H) L35K(L) L40K(H) L40K(L)	DISTRIBUTION ² SEMIND DIRIND	VOLTAGE ³ MVOLT 347V	SOURCE OPTION ⁴ 90CRI Minimum 80CRI is standard if option is not selected	ACOUSTIC PANEL COLOR See last page for finish order codes Canopy and stem painted white	OAH ⁵
--------	-------	---	---	---------------------------------------	--	---	------------------

SOURCE¹ (Select one)

Dimmable 0-10V to 1%, Minimum 80CRI, within 3-step MacAdam

Source	Distribution	Delivered Lumens	Power (Watts)
L30K(H)	SEMIND	23,000	239
	DIRIND	21,500	238
L30K(L)	SEMIND	11,500	108
	DIRIND	11,000	108
L35K(H)	SEMIND	23,500	239
	DIRIND	22,000	238
L35K(L)	SEMIND	11,500	108
	DIRIND	11,000	108
L40K(H)	SEMIND	23,500	239
	DIRIND	22,000	238
L40K(L)	SEMIND	11,500	108
	DIRIND	11,000	108

*Note: multiply by 0.85 for 90CRI delivered lumens

DISTRIBUTION² (Select one)

SEMIND	Semi-indirect: 75% uplight, 25% downlight (approximate)
DIRIND	Direct-indirect: 55% uplight, 45% downlight (approximate)

VOLTAGE³ (Select one)

MVOLT fixture accepts 120 through 277 input voltage

MVOLT	120-277V, 50/60 Hz
347V	50/60 Hz

SOURCE OPTION⁴

Minimum 80CRI within 3-step MacAdam is standard if option is not selected

90CRI	Color rendering index minimum 90, minimum R9 value of 50 (lumen output reduced by 15%)
--------------	--

LUMEN MAINTENANCE RATING

L90 (reported)	>55,000
-----------------------	---------

Reported Lifetime per IES TM-21

IMPERIAL SABINS (ft²)

SAA	21.1
NRC	21.7

Divide imperial sabins by 10.8 to find metric sabins in m²

SAA (Sound Absorption Average) is the average of absorption coefficients in 1/3-octave increments from 200Hz to 2500Hz.

NRC (Noise Reduction Coefficient) is the average of the absorption coefficients at 250Hz, 500Hz, 1000Hz, and 2000Hz.

CP6122 CELEST HX (cont.)

Large 48" H - Acoustic Panels



ACOUSTIC BENEFITS

- Reduce echos, background noise
- Clearer conversations
- Improves peacefulness of the area
- Improve the look of the room

ACOUSTIC PANEL CLEANING

- Vacuum to remove dust and debris
- Clean with a clean damp cloth or with soap and water

STRUCTURAL BLOCKING DETAIL

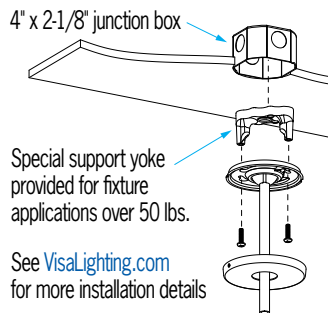

CELEST PRODUCT FAMILY

	Description	Model
Metal Panels	Celest SQ - Large	• CP6100
	Celest HX - Large	• CP6102
	Celest TR - Large	• CP6104
	Celest SQ - Small	• CP6106
	Celest HX - Small	• CP6108
	Celest TR - Small	• CP6110
Acoustic Panels	Celest SQ - Large	• CP6120
	Celest HX - Large	• CP6122
	Celest TR - Large	• CP6124
	Celest SQ - Small	• CP6126
	Celest HX - Small	• CP6128
	Celest TR - Small	• CP6130

SUGGESTED VARIATIONS

- Alternate control options
- No top lens
- Custom graphic or pattern printing on the acoustic panels
- Custom colors & finishes
- Mix & match panel colors (metal & acoustic)
- Shapes/perf in shades
- Luminous & non-luminous cutouts with mascots, logos, phrases, etc.



See VisaLighting.com/products/Celest for more information

CP6122 CELEST HX (cont.)

Large 48" H - Acoustic Panels



ACOUSTIC PANEL COLORS (Select one)
Specify color code when ordering.

Canopy and stem painted white. For more information about our finishes visit visalighting.com/finishes/acoustic
100% recyclable polyester (PET) acoustic felt

